

NOTES:

- 1) CLOSED CELL EPDM SPONGE RUBBER (0.300 G/CM<sup>3</sup>)
- 2) 3/4" PAPER TAPE (0.004 LB/FT)

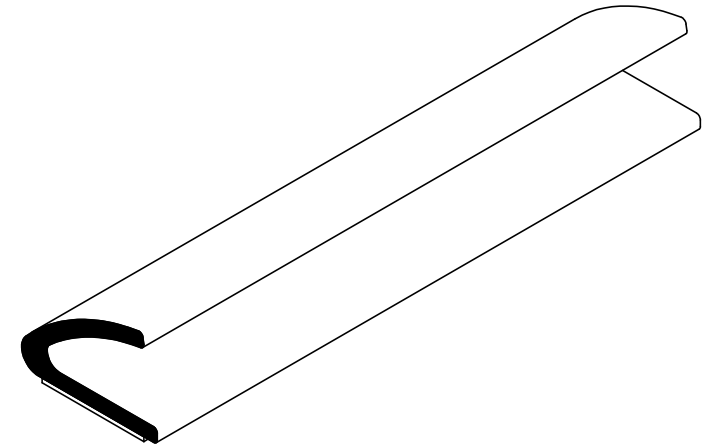
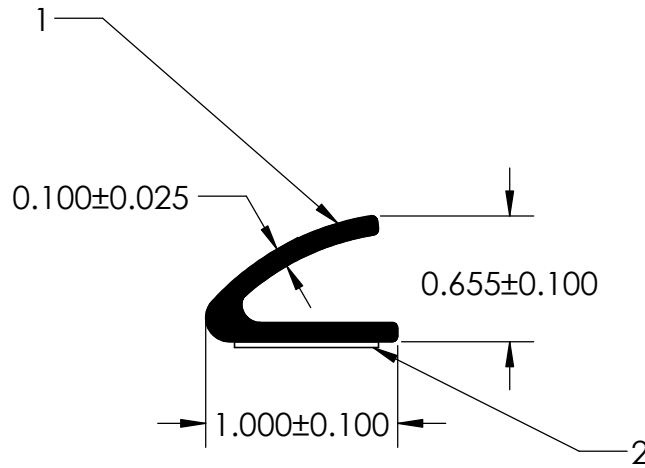

**UNI-GRIP, INC.**

9823 STATE ROUTE 53 N  
UPPER SANDUSKY, OHIO 43351

PROPRIETARY AND CONFIDENTIAL:	UNLESS OTHERWISE SPECIFIED:
THE INFORMATION CONTAINED IN THIS DRAWING IS THE SOLE PROPERTY OF UNI-GRIP, INC. ANY REPRODUCTION IN PART OR AS A WHOLE WITHOUT THE WRITTEN PERMISSION OF UNI-GRIP, INC. IS PROHIBITED.	DIMENSIONS ARE IN INCHES TOLERANCES PER ARPM CLASS 3
	WEIGHT 0.028 LB/FT
	ASTM D1056 2A2
DOCUMENT CONTROL NUMBER UG-1-EN-001-FR-(111416)	ASTM D2000 N/A

TITLE:		TS-038	
SIZE <b>A</b>	DWG. NO. UG-1-TS-750-PT-038	REV <b>A</b>	