

NOTES:

- 1) CLOSED CELL EPDM SPONGE RUBBER(0.536 G/CM³)
- 2) 70 DUROMETER DENSE RUBBER (1.200 G/CM³)
- 3) 1.430" WIRE CARRIER (0.033 LB/FT)

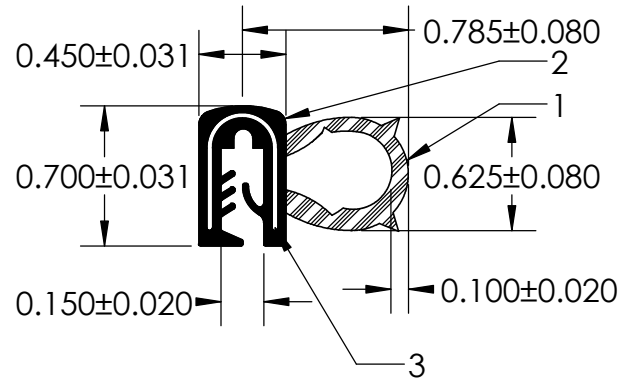
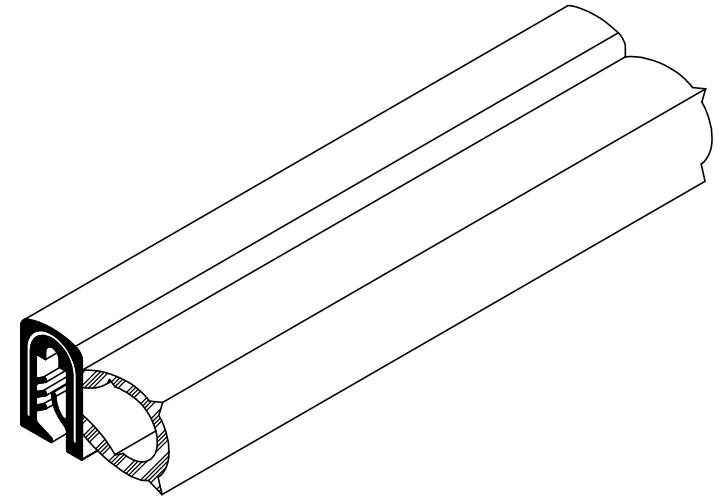

UNI-GRIP, INC.

9823 STATE ROUTE 53 N
UPPER SANDUSKY, OHIO 43351

PROPRIETARY AND CONFIDENTIAL:	UNLESS OTHERWISE SPECIFIED:
THE INFORMATION CONTAINED IN THIS DRAWING IS THE SOLE PROPERTY OF UNI-GRIP, INC. ANY REPRODUCTION IN PART OR AS A WHOLE WITHOUT THE WRITTEN PERMISSION OF UNI-GRIP, INC. IS PROHIBITED.	DIMENSIONS ARE IN INCHES TOLERANCES PER ARPM CLASS 3
	WEIGHT 0.181 LB/FT
	ASTM D1056 2A3
DOCUMENT CONTROL NUMBER UG-1-EN-001-FR-(111416)	ASTM D2000 3BA711 A14 B13 C12 F17

TITLE: SD-12124		
SIZE A	DWG. NO. UG-1-DU-1430-WR-047	REV A